

***i*NMOTION**

V6

Electric Unicycle User Manual

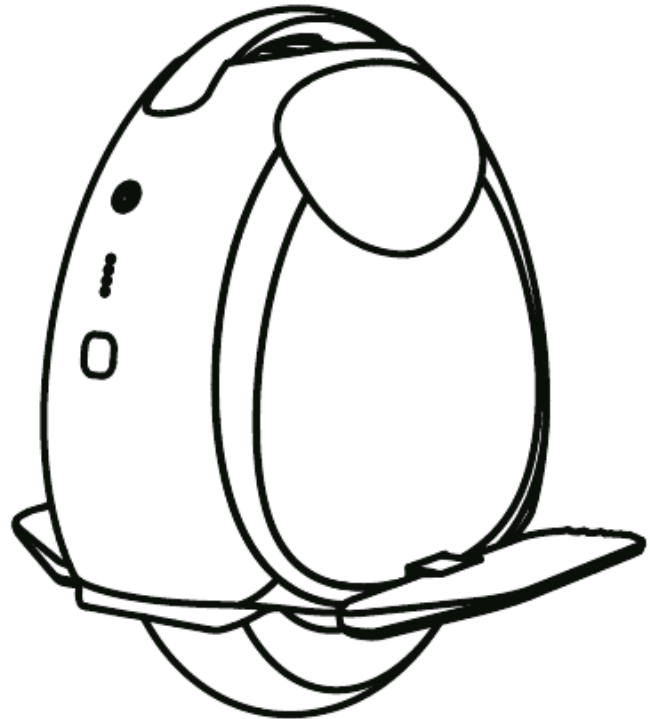

Before using your unicycle, please read the instructions, and keep this manual for ready reference.
Original instructions

***i* NMOTION**

GETTING STARTED

Thank you for choosing the INMOTION electric unicycle(hereinafter referred to as the unicycle)! This unicycle is an intelligent high-tech entertainment product. When you use the unicycle, there may be situations such as falling or collision that can cause injury and other risks. To reduce possible risks and ensure the personal and property safety of yourself and others, you have the responsibility and obligation to carefully read the user manual, fully understand all the warnings and precautions listed in this manual, and ensure that you can use it correctly. To obtain the latest feature/function information and safety guidance, please download the electronic version from the official website.

Important! Read carefully and keep for future reference.

Serial number (referred to as SN below) is a unique identifier for each product, which can be used for product warranty, maintenance, insurance claims, loss confirmation, and so on. The SN is a 16-character numeric code that can be found on the packaging box label, the body of the product, or in the device information section of the INMOTION App.

Get closer to your seller so he can refer you to an appropriate training organization.

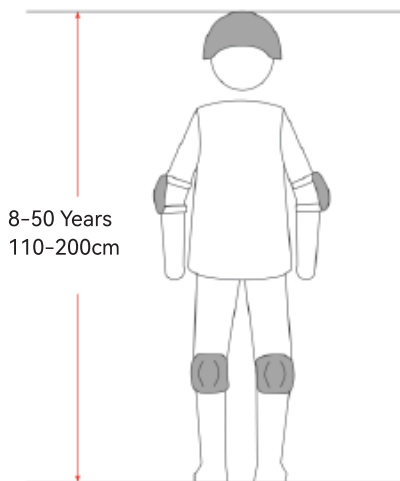

When riding an electric unicycle, please wear a helmet, knee pads, elbow pads, wrist guards and other protective gear throughout the journey to reduce the risk of injury.

All pictures in this manual are for reference only. Please refer to the actual product for accuracy.

PACKING LIST

Please carefully check all components inside the packaging. If any components are missing, please consult your point of purchase.

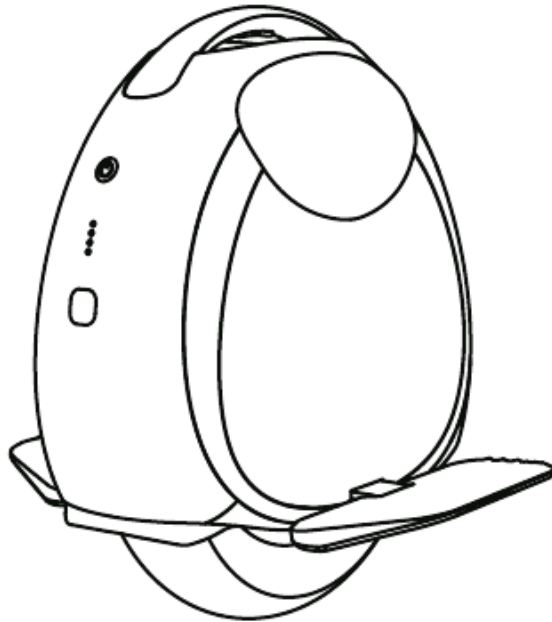

User Manual

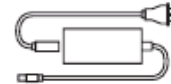

Power Cord /Adapter



WARNING: Please keep the packaging box and packaging materials for at least 30 days for future use when transporting the electric unicycle.

DIAGRAM

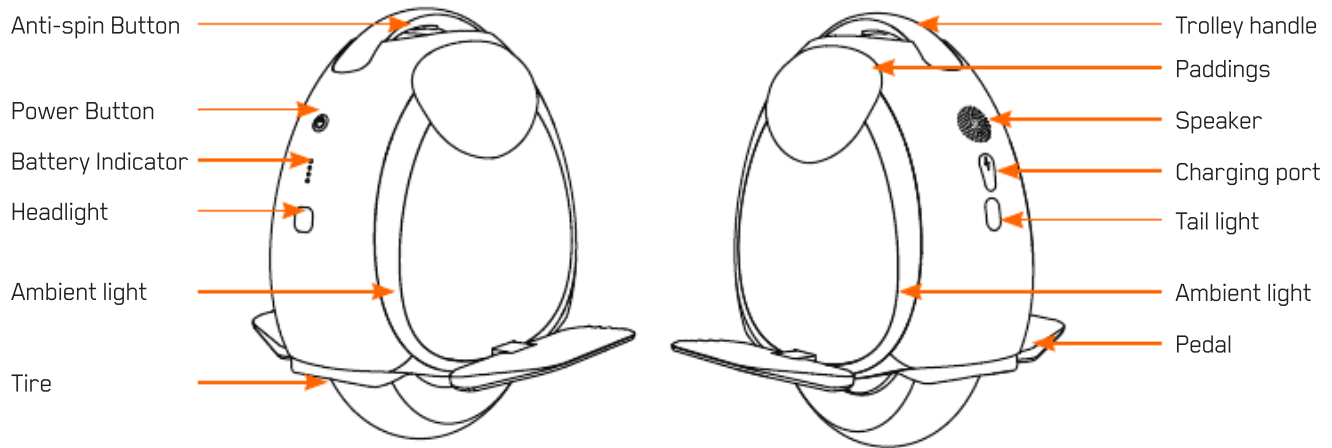

PRODUCT FEATURES

Power On/Off: LPress and hold the power button for 1 second when the device is off/on to turn it on/off.

HEADLIGHT: When the device is on, press the power button briefly to turn the headlight on/off. The headlight can also be controlled via the App.

Lock: Lock and unlock the vehicle through the lock icon in the App (only the verified owner can lock/unlock the vehicle).

Ride Mode Selection: Choose between Beginner Mode, Normal Mode, and Sport Mode through the App (beginner mode is the default setting).

Active Disable: Double-click the power button to lose balance (double-click again after righting the vehicle to regain balance).

Tail light: The tail light is off during normal riding; it flashes brightly when braking.

Ambient Light: Customize in the App.

Speaker: Connect to a phone via Bluetooth to play music.

Charging

The original charger is 54.6V. For the battery indicator: 0-25%, four bars flash in a cycle; 25-50%, one bar is solid, three bars flash in a cycle; 50-75%, two bars are solid, two bars flash in a cycle; 75-100%, three bars are solid, one bar flashes in a cycle; 100%, four bars are solid. (Warning: Use the original charger for charging.)

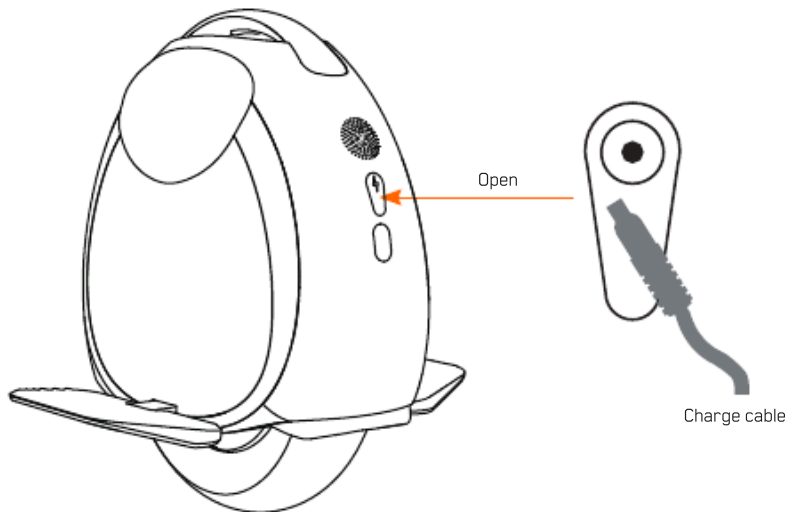

Warning:

- Do not charge if there is water at the charging port or power cord.
- Please use the original adapter for charging.
- Do not charge indoors.
- Cover the lid tightly after charging.
- Do not charge if the battery is damaged or has been exposed to water.
- If not in use for a long time, it is recommended to charge once every three months.

Note:

Tire Pressure: Maintain approximately 3.0 bar in both tires, ensuring they have equal pressure.

Moving vehicle: When lifting the vehicle, please turn it off first.

DIAGRAM

Basic Specs	Model	V6
	Range (km)	30 ^[1]
	Charging Time (h)	About 3.5h
	Max. speed (Km/h)	25 ^[2]
	Max. slope (°)	18° ^[3]
Frame	Length*Width*Height (mm)	440*253*486
	Net Weight (kg)	12.5
	Max. payload (kg)	90
	IP Ratings	IP55
Battery Pack	Rated Capacity (Wh)	234
	Rated Voltage (V)	48
Motor	Rated Power (w)	450
	Max.Power (w)	900
	Tire Size	90/80-8
	Tire Pressure (BAR)	2.3
	IP Ratings for Motor	IPX5
Charger	Charger Input	54.6
	Charger Output (W)	54.6V--1.0A

[1]: Under full charge conditions, with a 70kg load, at an ambient temperature of 25°C, and traveling at 60% of the maximum speed on a flat, hard surface, the range was measured. The range is influenced by factors such as temperature, tire pressure, road conditions, and riding habits (such as rapid acceleration and suspension).

[2]: The range was measured on a flat surface, with a 70kg load, at 25°C, in calm weather, under full charge conditions.

[3]: The actual range was measured under full charge conditions with a 70kg load.

DIMENSION

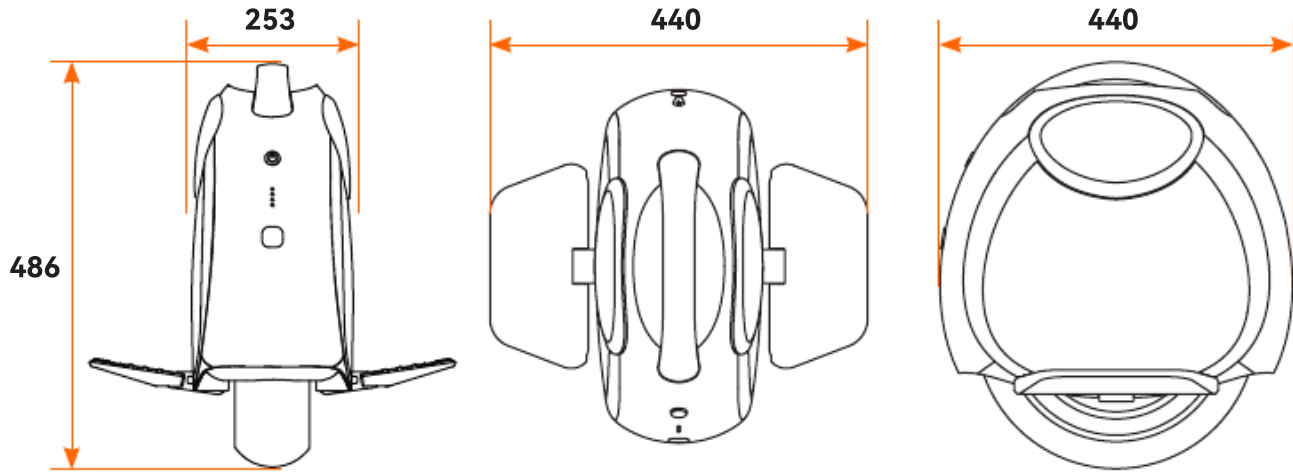

INITIAL USE

Activation

1. Users need to connect to the INMOTION App to activate the vehicle. Without activation, the vehicle remains in transport mode, unable to balance, with the tail light flashing as a reminder.
2. After activation through the App, the vehicle automatically exits transport mode and enters Beginner Mode.
3. A prompt to authorize as the owner appears after activation is complete.

INITIAL USE

Electric Unicycle is a high-tech recreation product. When you ride without following the operation specifications, it may lead to unpredictable injuries and property losses. The following will explain how to use Electric Unicycle and the precautions in details. Please read it carefully and use Electric Unicycle as required. Before using, please make sure that all parts of Electric Unicycle are not damaged and installed properly.

Warning:

- **Before using the Electric Unicycle, ensure that the battery is fully charged. It is recommended to charge it more than 80 percent of capacity.**
- **Find a relatively open and flat area to practice riding, (at least 4m by 4m in area), both inside and outside. You need to be fully aware of the riding environment around you to ensure that you are not disturbed by obstacles such as cars, pedestrians, pets, bicycles, etc.**
- **You need a skilled assistant stood by. The assistant must be familiar with Electric Unicycle and all precautions and usage methods in this manual.**
- **Please do not ride the vehicle on slippery ground.**
- **Users are advised to wear comfortable, casual or sports clothing, and to wear flats and warm up to improve your flexibility.**
- **Be sure to wear a helmet and riding protective gear to avoid injury.**

Download INMOTION App



Download the App in the following ways

1. Scan the QR code on the left
2. Search "INMOTION" in the Apple store or Google Play Store.
3. Visit <https://inmotionworld.com/app/>

Tips:

Electric Unicycle supports Bluetooth 5.0 BLE. The BLE ID is V12Pro-XXXXXXXX, where XXXXXXXX is the last 8 digits of SN. Install the INMOTION App on your mobile device (iOS 12.1 and above or Android 7.0 and above supported) and follow the prompts to connect your Electric Unicycle.

For more functions, please visit the official website to download the latest version of INMOTION App user manual.

LEARNING TO RIDE

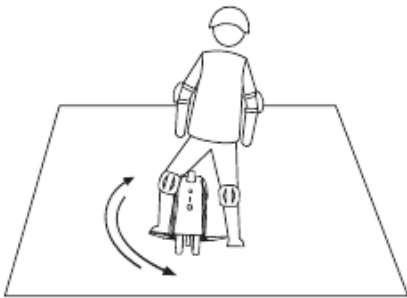

1. Step on the pedal with one foot, then swing back and forth.



2. Step on the pedal with one foot, keep your feet and body upright and gradually shift your weight up.



3. Step on the pedal with one foot, lift the other foot off the ground for 1-2 seconds and start gliding.

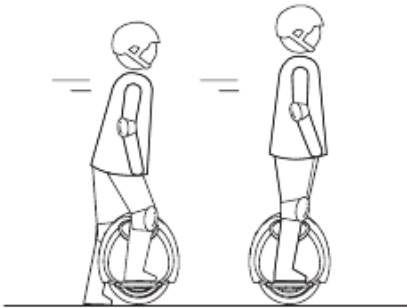

4. Step on the pedal with one foot, push back with the other foot and start gliding.

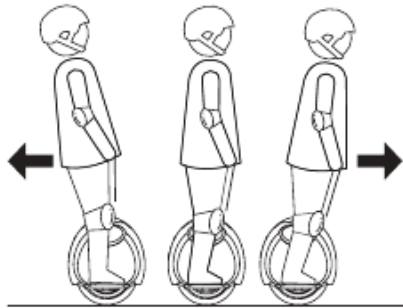

5. Step on pedals with both feet, use your weight to move forward and back.

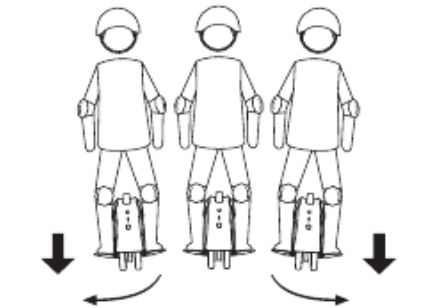

6. Press the pedals with feet by different force to make a turn.



INMOTION App



Facebook group



Website